

**T90 Series, 30A PCB Relay**

- 30A, 1 form A (NO); 20A, 1 form C (CO)
- Available as open frame or sealed construction
- Meets UL 508 and 873 Spacing - 3.18 through air, 6.36 over surface
- UL class F insulation system standard

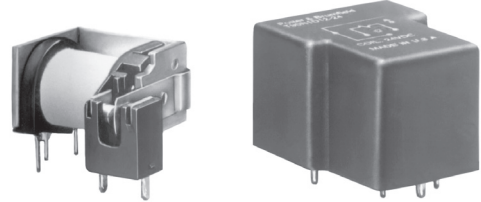

Typical applications  
HVAC, Appliances, Industrial Controls.

**Approvals**

UL E22575; CSA LR15734  
Technical data of approved types on request.

**Contact Data**

|   |   |
|---|---|
| Contact arrangement                         | 1 form A (NO), 1 form B (NC), 1 form C (CO) |
| Rated voltage                               | 277VAC                                      |
| Max. switching voltage                      | 277VAC                                      |
| Rated current                               | 30A   |
| Limiting continuous current                 | 30A   |
| Limiting making current                     | 30A   |
| Limiting breaking current                   | 30A   |
| Contact material                            | AgCdO                                       |
| Min. recommended contact load               | 1A, 5VDC or 12VAC                           |
| Initial contact resistance                  | 75 mΩ at 1A at 5VDC or 12VAC                |
| Frequency of operation, with load           | 360hr                                       |
| Operate/release time max., including bounce | 15/15ms                                     |

**Contact ratings**

| Type                    | Load                             | Cycles              |
|-------------------------|----------------------------------|---------------------|
| <b>Typical</b>          |                                  |                     |
| AgCdO, open style relay |                                  |                     |
| NO                      | 30A, 240VAC, general purpose     | 100x10 <sup>3</sup> |
| NO                      | 20A, 240VAC, resistive heater    | 100x10 <sup>3</sup> |
| CO                      | 20A/10A, 240VAC, general purpose | 100x10 <sup>3</sup> |
| CO                      | 20A/10A, 28VDC, resistive        | 100x10 <sup>3</sup> |

**UL 508/873**

| Type  | Load                                 | Cycles              |
|-------|--------------------------------------|---------------------|
| AgCdO |                                      |                     |
| NO    | 30A, 240VAC, general purpose         | 100x10 <sup>3</sup> |
| NC    | 15A, 240VAC, general purpose         | 100x10 <sup>3</sup> |
| CO    | 20A/10A, 240VAC, general purpose     | 100x10 <sup>3</sup> |
| NO    | 20A, 240VAC, resistive               | 100x10 <sup>3</sup> |
| NC    | 15A, 240VAC, resistive               | 100x10 <sup>3</sup> |
| CO    | 20A/10A, 240VAC, resistive           | 100x10 <sup>3</sup> |
| NO    | 80LRA/30FLA, 240VAC                  | 30x10 <sup>3</sup>  |
| NC    | 30LRA/10FLA, 240VAC                  | 30x10 <sup>3</sup>  |
| CO    | 53.6LRA/20FLA / 20LRA/6.7FLA, 240VAC | 100x10 <sup>3</sup> |
| NO    | 98LRA/22FLA, 120VAC                  | 100x10 <sup>3</sup> |
| NO    | 2HP, 240VAC                          | 1x10 <sup>3</sup>   |
| NC    | 1/2HP, 240VAC                        | 1x10 <sup>3</sup>   |
| NO    | 1HP, 120VAC                          | 1x10 <sup>3</sup>   |
| NC    | 1/4HP, 120VAC                        | 1x10 <sup>3</sup>   |
| NO    | 6A, 277VAC, ballast                  | 100x10 <sup>3</sup> |
| NC    | 3A, 277VAC, ballast                  | 6x10 <sup>3</sup>   |
| NO    | TV5, 240VAC, tungsten                | 6x10 <sup>3</sup>   |
| NC    | TV3, 240VAC, tungsten                | 6x10 <sup>3</sup>   |
| NO    | 20A, 28VDC, resistive                | 100x10 <sup>3</sup> |
| NC    | 10A, 28VDC, resistive                | 100x10 <sup>3</sup> |

All ratings at 25°C (unless otherwise noted) with relay properly vented. Remove vent nib from enclosed relays after soldering and cleaning for optimum life.

Mechanical endurance 10x10<sup>6</sup> ops.

**Coil Data**

|                                     |             |
|-------------------------------------|-------------|
| Coil voltage range                  | 5 to 110VDC |
| Max. coil power                     | 1.0W        |
| Max. coil temperature               | 155°C       |
| Coil insulation system according UL | Class F     |

**Coil versions, DC coil**

| Coil code | Rated voltage VDC | Operate voltage VDC | Release voltage VDC | Coil resistance Ω±10% | Rated coil power W |
|-----------|-------------------|---------------------|---------------------|-----------------------|--------------------|
| 5         | 5                 | 3.75                | 0.5                 | 27                    | 900                |
| 6         | 6                 | 4.5                 | 0.6                 | 40                    | 900                |
| 9         | 9                 | 6.75                | 0.9                 | 97                    | 900                |
| 12        | 12                | 9                   | 1.2                 | 155                   | 900                |
| 18        | 18                | 13.5                | 1.8                 | 380                   | 900                |
| 24        | 24                | 18                  | 2.4                 | 660                   | 900                |
| 48        | 48                | 36                  | 4.8                 | 2560                  | 900                |
| 110       | 110               | 82.5                | 11                  | 13450                 | 900                |

All figures are given for coil without preenergization, at ambient temperature +23°C.

**Ambient temperature vs. coil voltage - 1W coil**

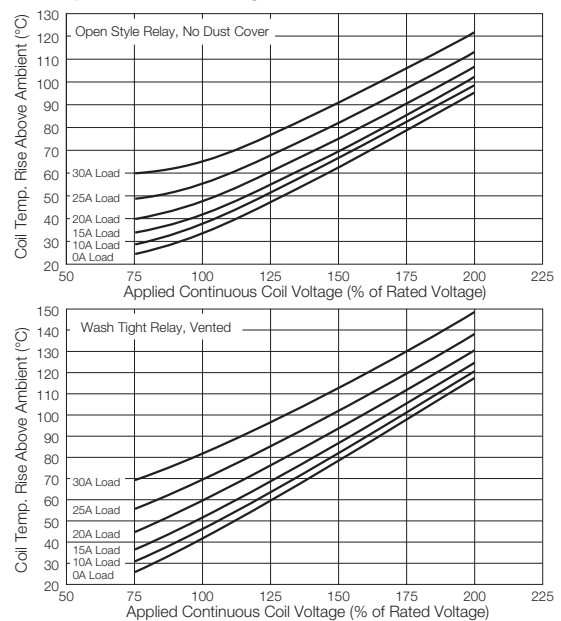

Data graphed above are average values and should be verified in application. Tests were conducted within a 2' (.6m) cube (still air); at nominal coil power @ 25°C; with normally open contact loaded; and with 4' (1.22m) long, #10AWG load wires. P.C. board relays were mounted to a 30A, single side P.C. board. Coil rise test conducted with a 30A PC board to maintain 20°C max. rise at 30°C. The relay connections and wiring must be designed with an adequate cross section to ensure proper current flow and heat dissipation. After cleaning process knock-off nib should be removed for optimum life of wash-tight relays.

**T90 Series, 30A PCB Relay (Continued)**

**Insulation Data**

|                               |                      |
|-------------------------------|----------------------|
| Initial dielectric strength   |                      |
| between open contacts         | 1500V <sub>rms</sub> |
| between contact and coil      | 1500V <sub>rms</sub> |
| Initial insulation resistance |                      |
| between insulated elements    | 1x10 <sup>9</sup> Ω  |
| Clearance/creepage            |                      |
| between contact and coil      | 3.17mm               |

**Other Data**

Material compliance: EU RoHS/ELV, China RoHS, REACH, Halogen content refer to the Product Compliance Support Center at [www.te.com/customersupport/rohssupportcenter](http://www.te.com/customersupport/rohssupportcenter)

|                                      |                                |
|--------------------------------------|--------------------------------|
| Ambient temperature                  |                                |
| DC coil                              | -55°C to 85°C <sup>1)</sup>    |
| Category of environmental protection |                                |
| IEC 61810                            | RT0 - open, RTIII - wash tight |

**Other Data (continued)**

|                                   |  |
|-----------------------------------|--|
| Vibration resistance (functional) | 1.65mm max excursions, 10-55 Hz        |
| Shock resistance (functional)     | 10g for 11msec                         |
| Shock resistance (destructive)    | 100g                                   |
| Terminal type                     | PCB-tht                                |
| Weight                            | 20g open relay<br>26g wash-tight relay |
| Resistance to soldering heat THT  |  |
| IEC 60068-2-20                    | 250°C                                  |
| Packaging/unit                    | tray/50 pcs., box/500 pcs.             |

1) Operating ambient temperature must consider "Must Operate Voltage Change Over Temperature," Contact Temperature Rise, Coil Temperature Rise (if coil is not allowed to cool) and Maximum Coil Temperature. Specification ambient considers 20A load with coil cooled to ambient.

**Dimensions**

T90N

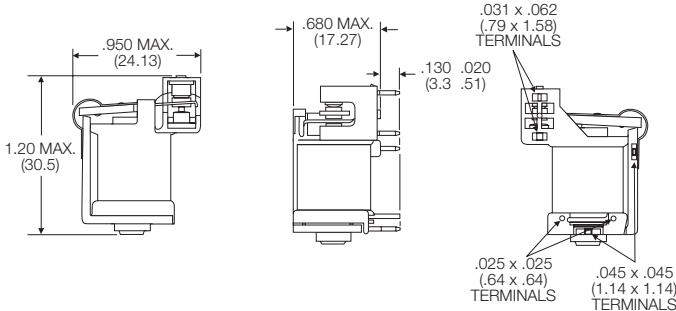

T90S

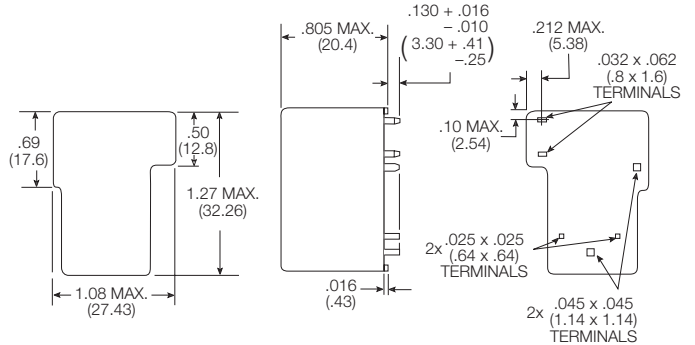

**Terminal assignment**

Bottom view on pins

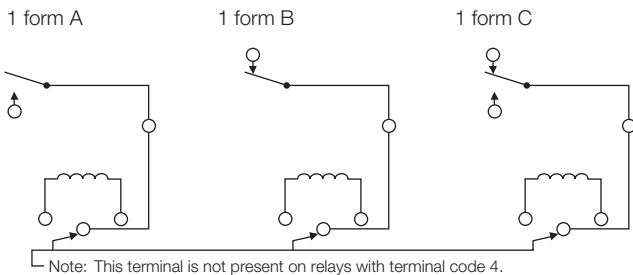

**PCB layout**

Bottom view on pins

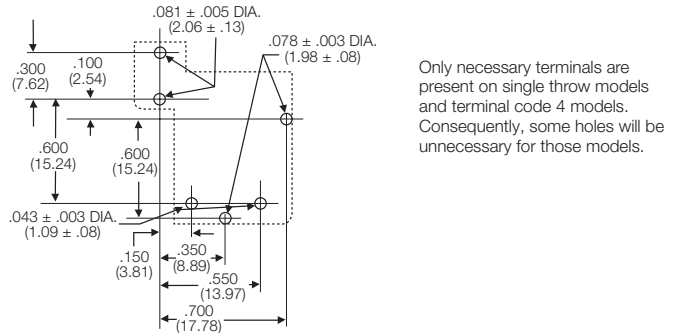

**Accessory**

Optional plastic dust cover is a snap-on unit, open on the PC board side of the relay. The cover, when ordered with the relay, is shipped separately. It is designed to be snapped into place by the customer after the relay has been assembled to the PC board.

| Product Code | Description                             | Part Number |
|--------------|---|-------------|
| 35C620A      | Black dust cover, for use on T90N relay | 4-1393209-2 |

35C620A

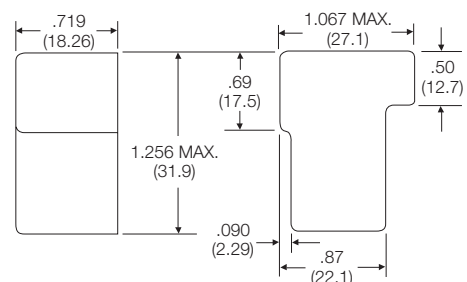

**T90 Series, 30A PCB Relay** (Continued)

|                                 |  |  |  |                   |          |                   |          |          |          |            |
|---------------------------------|--|--|--|-------------------|----------|-------------------|----------|----------|----------|------------|
| <b>Product code structure</b>   |  | Typical product code   |  | <b>T90</b>        | <b>S</b> | <b>5</b>          | <b>D</b> | <b>1</b> | <b>2</b> | <b>-24</b> |
| <b>Type</b>                     |  | T90 Power PCB relay T90  |  |                   |          |                   |          |          |          |            |
| <b>Enclosure</b>                |  | N Open, no enclosure (snap-on dust cover available as an option)<br>S Wash-tight, sealed plastic case with knock off nib for ventilation   |  |                   |          |                   |          |          |          |            |
| <b>Contact arrangement</b>      |  | 1 1 form A (1 NO)  |  | 2 1 form B (1 NC) |          | 5 1 form C (1 CO) |          |          |          |            |
| <b>Coil Input</b>               |  | D DC voltage   |  |                   |          |                   |          |          |          |            |
| <b>Mounting and termination</b> |  | 1 PCB terminals<br>4 PCB terminals, no common terminal between coil terminals (see PCB layout/terminal assignment drawing)<br>Note: Terminal code 4 recommended for UL 873 applications. Consult factory for use of terminal code 1 for UL 873 applications. |  |                   |          |                   |          |          |          |            |
| <b>Contact material</b>         |  | 2 AgCdO  |  |                   |          |                   |          |          |          |            |
| <b>Coil voltage</b>             |  | Coil code: please refer to coil versions table   |  |                   |          |                   |          |          |          |            |

| Product Code | Enclosure      | Contacts       | Terminals         | Contact Material | Coil    | Part Number |
|--------------|----------------|----------------|-------------------|------------------|---------|-------------|
| T90N1D12-5   | open, no cover | 1 form A, 1 NO | PCB               | AgCdO            | 5 VDC   | 7-1393208-4 |
| T90N1D12-9   |                |                |                   |                  | 9 VDC   | 7-1393208-5 |
| T90N1D12-12  |                |                |                   |                  | 12 VDC  | 6-1393208-5 |
| T90N1D12-18  |                |                |                   |                  | 18 VDC  | 6-1393208-8 |
| T90N1D12-24  |                |                |                   |                  | 24 VDC  | 7-1393208-0 |
| T90N1D12-48  |                |                |                   |                  | 48 VDC  | 7-1393208-3 |
| T90N1D12-110 |                |                |                   |                  | 110 VDC | 6-1393208-4 |
| T90N1D42-12  |                |                | PCB, no extra COM |                  | 12 VDC  | 7-1393208-7 |
| T90N1D42-24  |                |                |                   |                  | 24 VDC  | 7-1393208-9 |
| T90N5D12-5   |                | 1 form C, 1 CO | PCB               |                  | 5 VDC   | 9-1393208-5 |
| T90N5D12-12  |                |                |                   |                  | 12 VDC  | 8-1393208-6 |
| T90N5D12-18  |                |                |                   |                  | 18 VDC  | 9-1393208-0 |
| T90N5D12-24  |                |                |                   |                  | 24 VDC  | 9-1393208-3 |
| T90N5D12-48  |                |                |                   |                  | 48 VDC  | 9-1393208-4 |
| T90N5D12-110 |                |                |                   |                  | 110 VDC | 8-1393208-5 |
| T90N5D42-12  |                |                | PCB, no extra COM |                  | 12VDC   | 9-1393208-9 |
| T90N5D42-24  |                |                |                   |                  | 24 VDC  | 1393209-2   |
| T90S1D12-5   | wash tight     | 1 form A, 1 NO | PCB               |                  | 5 VDC   | 1-1393209-8 |
| T90S1D12-6   |                |                |                   |                  | 6 VDC   | 1-1393209-9 |
| T90S1D12-9   |                |                |                   |                  | 9 VDC   | 2-1393209-0 |
| T90S1D12-12  |                |                |                   |                  | 12 VDC  | 1-1393209-2 |
| T90S1D12-18  |                |                |                   |                  | 18 VDC  | 1-1393209-3 |
| T90S1D12-24  |                |                |                   |                  | 24 VDC  | 1-1393209-6 |
| T90S1D42-12  |                |                | PCB, no extra COM |                  | 12 VDC  | 2-1393209-2 |
| T90S1D42-24  |                |                |                   |                  | 24 VDC  | 2-1393209-5 |
| T90S1D42-48  |                |                |                   |                  | 48 VDC  | 2-1393209-6 |
| T90S5D12-5   |                | 1 form C, 1 CO | PCB               |                  | 5 VDC   | 3-1393209-4 |
| T90S5D12-12  |                |                |                   |                  | 12 VDC  | 2-1393209-8 |
| T90S5D12-18  |                |                |                   |                  | 18 VDC  | 3-1393209-0 |
| T90S5D12-24  |                |                |                   |                  | 24 VDC  | 3-1393209-1 |
| T90S5D12-48  |                |                |                   |                  | 48 VDC  | 3-1393209-3 |
| T90S5D42-12  |                |                | PCB, no extra COM |                  | 12 VDC  | 1423094-1   |
| T90S5D42-18  |                |                |                   |                  | 18 VDC  | 3-1393209-8 |
| T90S5D42-24  |                |                |                   |                  | 24 VDC  | 4-1393209-0 |